

Whitecap

Units	INCHES	View	
P/N	6005-A		20170813

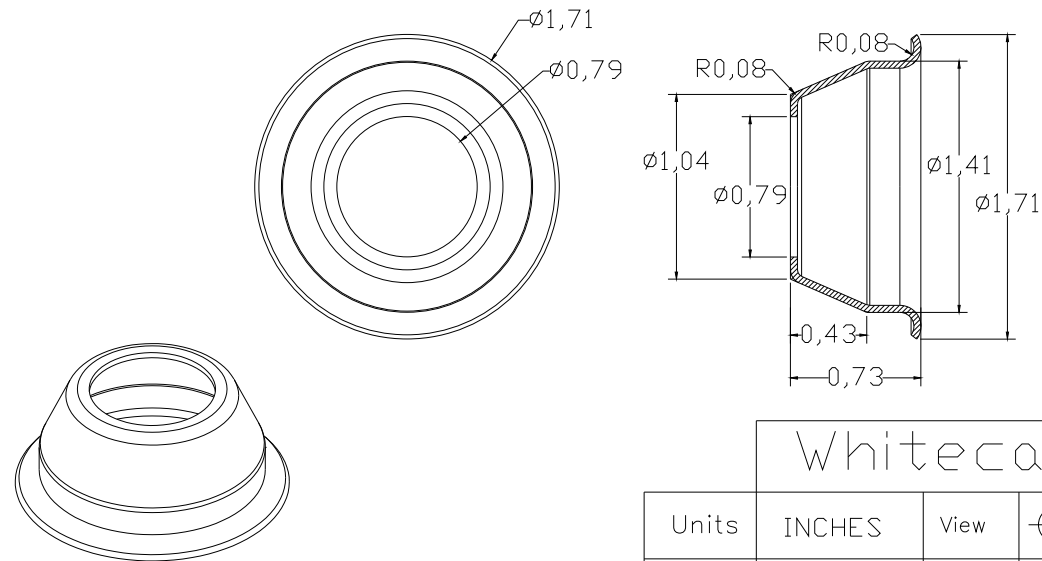
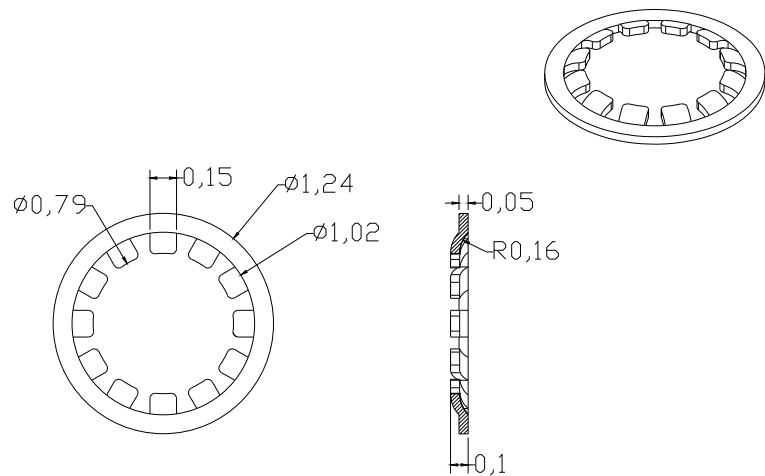
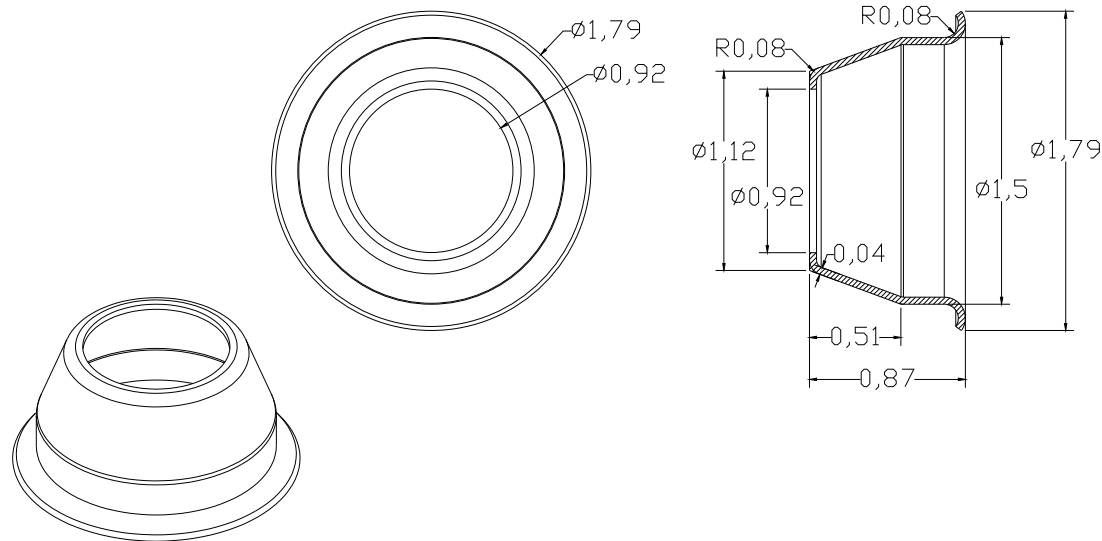
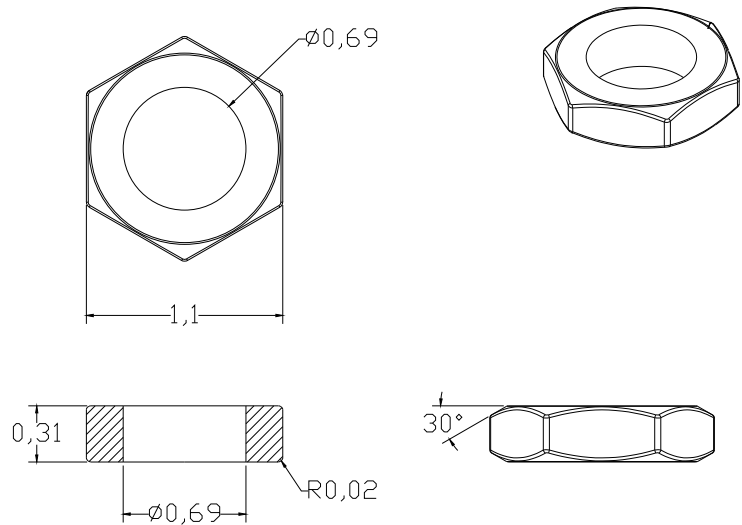

Whitecap

Units	INCHES	View	
P/N	6005-B		20170813