

Whitecap

Units	INCHS	View	
P/N	6094-A		20171218

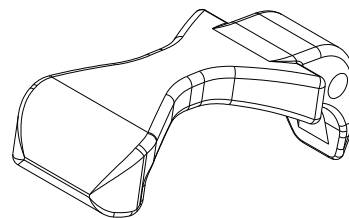
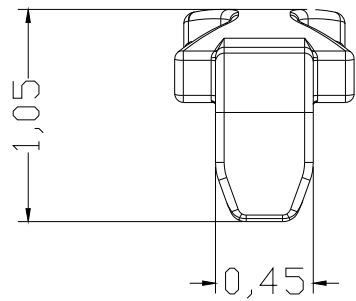
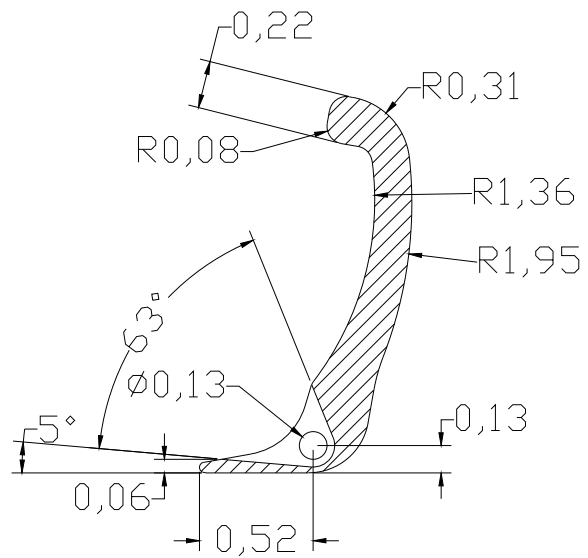
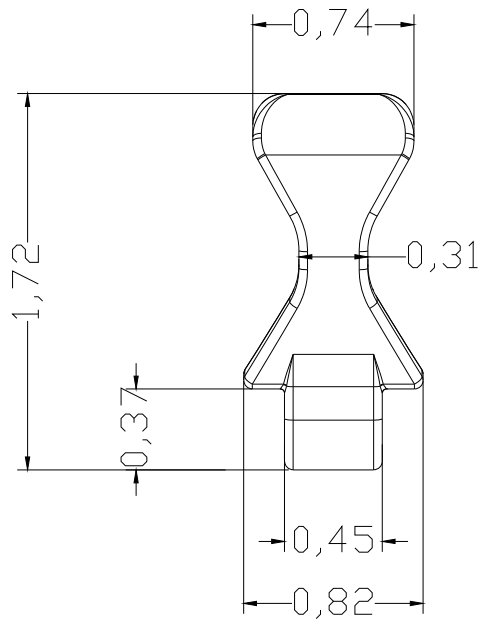

Whitecap

Units	INCHS	View	
P/N	6094-B		20171218

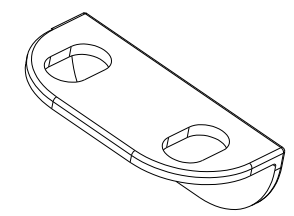
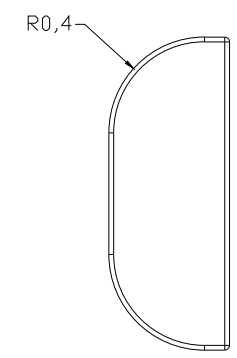
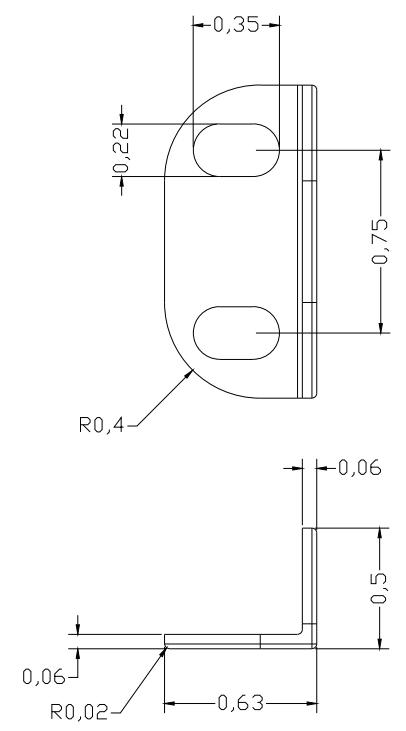
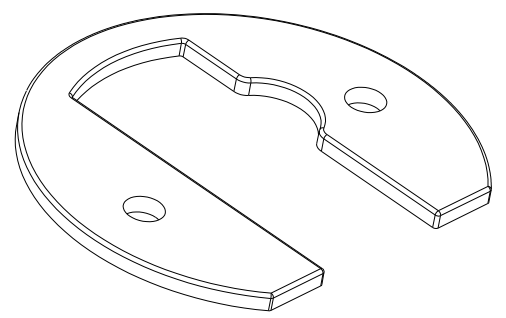
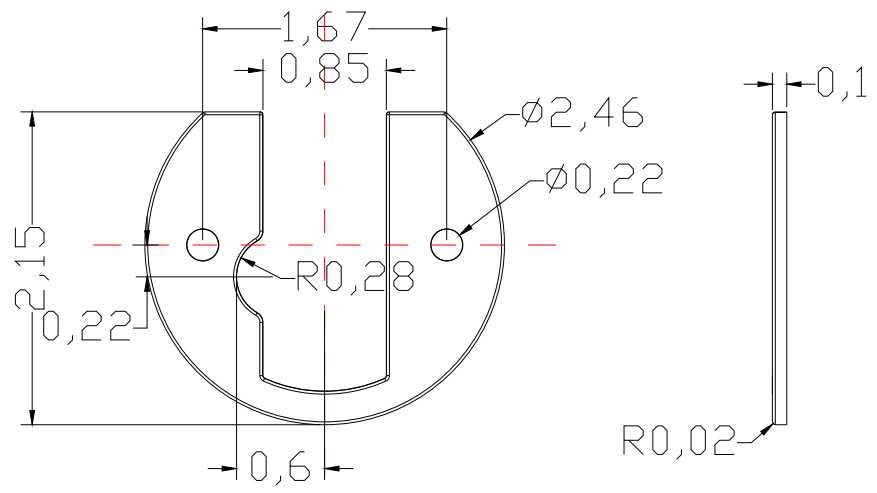

Whitecap

Units	INCHS	View	
P/N	6094-C		20171218